

Mistral-Air[®]

Forced Air Warming



MA1200-EU/US



MA1200-QC-EU/US

User Manual

Forced Air Warming System

This page is intentionally left blank.

Contents

1 General information.....	5
1.1 About this manual.....	5
1.2 Intended use.....	5
1.3 Indications for use.....	5
1.4 Contact.....	5
1.5 Warranty.....	6
1.6 Authorization of personnel and training.....	7
1.7 Warning, caution and note.....	7
1.8 Disclaimer.....	8
1.9 Intellectual property statement.....	8
2 Contraindications, warnings, cautions and notes.....	9
2.1 Contra-indications.....	9
2.2 Warnings.....	9
2.3 Cautions.....	11
2.4 Notes.....	12
2.5 List of Symbols.....	12
3 Description.....	19
3.1 Overview of the Mistral-Air Warming Unit MA1200.....	19
3.2 Overview of the Mistral-Air Warming Unit MA1200-QC.....	20
3.3 Overview of the control panel.....	20
3.4 Visual and audible warning systems.....	21
3.4.1 Technical alarm.....	22
3.4.2 Overtemperature alarm.....	23
3.4.3 Microcontroller watchdog alarm.....	23
3.4.4 Filter replacement indicator.....	23
3.4.5 Temporarily audible alarm suppression.....	24
4 For Use With.....	25
5 Single-use items, accessories and spare parts.....	26
5.1 Mistral-Air Adjustable Pole (MA5200).....	27
5.2 Mistral-Air MA1200 - Mounting Parts.....	29
5.3 Mistral-Air QC Hose - (MA1018-QC) and QC Hose XL (MA1018XL-QC).....	30
5.4 Mistral-Air blankets and suits.....	30
6 Installation.....	34
6.1 Transport and storage.....	34
6.2 Connecting the power supply cord.....	34
6.3 Attaching the mounting parts.....	34
7 Operation.....	37

7.1 Safety instructions before operation.....	37
7.2 Cybersecurity.....	37
7.3 Connecting the Mistral-Air QC Hose (MA1200-1018 & MA1200-1018XL) to the device.....	37
7.4 Connecting the power supply.....	38
7.5 Connecting the blanket.....	38
7.6 Turning on the device.....	38
7.7 Selecting the temperature.....	39
7.8 Stopping warming.....	39
8 Maintenance.....	40
8.1 Cleaning.....	41
8.2 Disinfection.....	42
8.3 Corrective maintenance.....	42
8.3.1 Replacing the Mistral-Air Filter (MA1200-1001).....	42
8.3.2 Replacing the Mistral-Air Hose (MA1018 & MA1018XL).....	45
8.3.3 Replacing the Mistral-Air QC Hose (MA1018 & MA1018XL).....	47
8.3.4 Replacing the power cord.....	48
9 Troubleshooting.....	50
10 Specifications.....	51
10.1 Specifications of the device.....	51
11 Electromagnetic compatibility.....	53
11.1 Electromagnetic immunity.....	53
11.2 Electromagnetic emissions.....	54
11.3 Recommended separation distances.....	55
12 Disposal/End of life.....	56
12.1 Active devices.....	56
12.2 Blankets and Suits or Single-use items.....	56

1 General information

1.1 About this manual

In this manual, you can find important information about how to operate the Mistral-Air® Warming Unit MA1200 - (MA1200- EU/US) and the Mistral-Air Warming Unit MA1200-QC - (MA1200-QC- EU/US) (hereafter referred to as 'the device, in combination with the Mistral-Air warming blankets and suits').

The manual assists with the operation and the maintenance of the system, in a safe and responsible manner. If during use or servicing any serious incident occurs, these should be reported to manufacturer and competent authority as soon as possible.

Read this manual carefully. Complete all the procedures. Perform the procedures in the given sequence. Always keep the manual with the system.

Please refer to the Mistral-Air technical manual for maintenance, repair and calibration instructions. Please contact your TSC Life sales representative in case you need the manual.

1.2 Intended use

The Mistral-Air MA1200 is a forced air warming system and comprises of a warming unit and a variety of blankets and suits. It is intended to raise and maintain patient temperature by means of surface warming.

1.3 Indications for use

The Mistral-Air Warming System is a forced air warming system and comprises of a warming unit and a variety of blankets and suits. It is intended to raise and maintain patient temperature by means of surface warming.

1.4 Contact

The Surgical Company International B.V.
Beeldschermweg 6F
3821 AH Amersfoort
The Netherlands

Phone: +31 (0)33 450 72 50
E-mail: letsconnect@tsc-life.com
Website: www.tsc-life.com

Refer to the website to find your local distributor.

1.5 Warranty

Subject to statutory limitations imposed by applicable law, Company warrants that the Units will be free from defects in material and workmanship for a period of two years from the date of shipment ready. THIS LIMITED WARRANTY IS IN LIEU OF ALL OTHER WARRANTIES, INCLUDING ANY IMPLIED WARRANTIES APPLICABLE TO THE UNITS, SUCH AS WARRANTIES OF MERCHANTABILITY AND FITNESS FOR A PARTICULAR PURPOSE, WHICH ARE HEREBY DISCLAIMED AND EXCLUDED BY THE COMPANY TO THE FULLEST EXTENT PERMITTED BY LAW.

This warranty applies only if the Unit is handled properly and used for the units intended use and in strict accordance with the instructions for use, including operating and care instructions, and provided that the User promptly informs Company of any alleged defect and supplies to Company the proof of purchase (indicating the date of purchase and the date of delivery).

Without limiting the foregoing, this warranty shall not apply if:

- the proof of purchase has been altered or is illegible in any way;
- repairs, modifications and/or alterations to the Unit have been performed by unauthorized service organizations or persons or by the User;
- parts of the Unit other than replacement parts made or approved by Company have been used, if such parts are the cause of damage or failure;
- the Unit was bought used or does not carry a TSC Life trademark Mistral-Air® and Fluido®;
- damage or failure is caused by accidents including but not limited to falls, bumps, short circuits, liquid or fire;
- damage or failure is caused by misuse, fault or negligence;
- the Unit has been used in conjunction with accessories not approved by Company for use with the Unit. More specifically, this limited warranty applies only for the use of Units with Company's disposable components. The use of any disposable components or parts not manufactured or approved by Company for use with Units invalidates this warranty;
- fraudulent or incorrect information has been provided to Company at the time the Unit is returned.

This limited warranty applies only to User and is non-transferable.

The parts listed below are not covered by this limited warranty or are covered for a more limited warranty period, as indicated:

PARTS	LIMITED WARRANTY PERIOD (From the Date of Shipment ready)
Filters	No warranty provided
Fuses	No warranty provided
Lamps	No warranty provided
Hoses	No warranty provided
Battery (pack)	No warranty provided
Bladders	No warranty provided
Power cord	1 year

PARTS	LIMITED WARRANTY PERIOD (From the Date of Shipment ready)
Fluido® IV pole	1 year
Mistral-Air® Poles with Basket	1 year
Mounting brackets	1 year
Fluido® Test equipment	1 year
Mistral-Air® Test equipment	1 year

Remedy; Limitations

Subject to the warranty conditions set forth above, if, during the limited warranty period, a Unit or part is found to be defective because of defects in materials and workmanship, it will be repaired or replaced without charge by an identical or at least equivalent Unit or part, subject to the continued availability of the model in question and provided that the approval of Company has been obtained for such repair or replacement in advance of the return of the defective unit to Company. Defective Units or parts must be returned to the distributor from whom the products were purchased. Repair or replacement of a Unit or part under the terms of this limited warranty does not extend the original limited warranty period, i.e., repaired or replaced Units or parts are covered by this limited warranty for the remaining validity period of the original warranty period. As indicated above, this warranty does not apply to certain parts, and other parts have a more limited warranty from their date of delivery to User. User's exclusive remedy, IN LIEU OF ALL INCIDENTAL, SPECIAL OR ON SEQUENTIAL DAMAGES OF ANY KIND, INCLUDING FOR NEGLIGENCE, is limited to repair or replacement of a defective Unit or part under the terms and conditions of this limited warranty. Company will bear no other liability or expenses. Repair and return or replacement costs will be charged for defects not covered by this limited warranty.

1.6 Authorization of personnel and training

The instructions contained in this manual are solely intended for authorized and certified personnel to work with and/or service the medical system(s) described herein.

1.7 Warning, caution and note



Warning!

A "warning" tells you that there is a risk of personal injury or death. [W000]



Caution!

A "caution" tells you that:

- there is a risk of damage to the system, and/or
- there is a risk of damage to other equipment. [C000]



A "note" provides more information. [N000]



Every "warning", "caution" and "note" is identified by a unique number in the format [W/C/N###]. [N015]

1.8 Disclaimer

The information and/or instructions mentioned in this manual do not contain any advice regarding a medical treatment in the broadest sense of the term. This manual is provided for general informational/ educational purposes and is meant as a guideline for the proper usage of the medical system(s) in question. Accordingly, before taking any actions based on this manual, the user shall be obliged to consult with the appropriate medical and healthcare professionals such as trained and certified clinicians.

The description and instructions regarding the medical system(s) mentioned in this manual have been compiled with the greatest possible care. Nonetheless, the user should be aware that The Surgical Company International B.V. can and may have made certain alternations and/or improvements regarding these medical system(s) which may not yet be adequately described in the current copy of the manual. Advisory notices and field safety corrections are always provided for important alterations in product use. All users are strongly advised to make sure that they consult the most recent version of the manual. Users are notified regarding updates to the manual by their TSC Life sales representative.

The original instructions in this document were created in English. All other language versions are translations of the original instructions. In the event of ambiguity and/or disputes, the English text always takes precedence.



Caution! Federal law restricts this system to sale by or on the order of a physician.

1.9 Intellectual property statement

This manual contains proprietary information of The Surgical Company International B.V. and all data mentioned herein are protected by copyright and patent laws and any other applicable statutory provisions regarding the protection of intellectual property, and may therefore not be reproduced, republished, disclosed to third parties, transmitted, displayed, broadcast or otherwise exploited in any manner whatsoever without the explicit prior written consent of The Surgical Company International B.V.. The name and logo of the The Surgical Company International B.V. and all related trademarks, trade names, and other intellectual property are and shall remain the exclusive property of The Surgical Company International B.V. and cannot be used without the latter's express prior written consent.

2 Contraindications, warnings, cautions and notes

2.1 Contra-indications

- Only apply heat to intact skin and do not apply heat directly to open wounds.
- Do not apply the warming system to ischemic limbs.
 1. Use caution and consider discontinuing use on patients during vascular surgery when an artery is clamped to an extremity (i.e. aortic cross-clamping).
 2. Use caution and monitor closely if used on patients with severe peripheral vascular disease.

2.2 Warnings



Warning!

- Do not use the system when it is damaged or when the Mistral-Air warming blanket or suit is damaged. This may result in thermal injury to the patient.
- Do not allow the patient to lie on or contact the hose with the skin when the system is active. This may result in thermal injury to the patient.
- Do not use the Mistral-Air warming blanket or suit to transfer or move the patient. This may result in thermal injury to the patient.
- To prevent tipping when mounting to an IV-pole, mount the system at a height at which the IV-pole is stable. If the IV-pole is unstable, injury may occur. Before usage, assess the stability by placing the IV-pole on a surface at an angle of 10° from the horizontal plane with brakes activated. The IV-pole may not overbalance, or move. Also passing over a 10 mm / 0.39 in. threshold may not result in overbalancing. Mass and position of center of gravity are provided in this IFU for theoretical analysis. The Surgical Company International B.V. cannot provide maximum mounting height prescriptions for different wheel base diameters, numbers of castors (either with brakes or not) and configurations of other equipment mounted to the IV pole.
- Do not use the system without a Mistral-Air warming blanket or suit connected to it (no free hosing). This may result in thermal injury to the patient.
- Do not use the system and blankets or suits near flammable anesthetics and/or in oxygen-enriched environment, to avoid the risk of explosion or fire.
- Check patient's temperature and skin condition at least every 15 minutes, or according to institutional protocol.
- Applying air with a temperature above the normothermic core body temperature range (36 – 37.5°C / 96.8- 99.5°F) incorporates the risk of hyperthermia. Depending on the selected set point, heating time, additional heat sources and insulation, the patient's body core temperature can rise above 37.5°C / 99.5°F. This may result in thermal injury to the patient.
- Pediatric patients of low weight will have a tendency to overheat more rapidly than adults. Failure to monitor core temperature could result in abnormal elevation of body temperature resulting in serious injury or death.
- A physician order is required for setting temperature and for continued use.

- If patient temperature is not responding to treatment or does not reach the desired temperature, notify a physician.
- Warming transdermal medications (patches) can increase drug delivery, resulting in possible harm to the patient.
- Avoid direct contact between a blanket or suit and a laser. Although the blankets or suits are flame retardant per 16 CFR Part 1610 (Standard for the flammability of clothing textiles) class 1, compliance with ISO 11810:2015 (classification for the laser resistance) is not demonstrated.
- Never fold the blankets or suits during use. This could lead to insufficient treatment.
- Do not obstruct blanket or suit channels by e.g. instruments/tape/clamps. This could lead to insufficient treatment.
- The system is fitted with a HEPA H13 class air filter (EN1822-1: 2019). However airborne contamination should be taken into consideration when using the forced air warming system to minimize the risk of infection for the patient.
- Before you clean the system, disconnect the power supply cord to eliminate the risk of electrocution.
- Clean the hose after each use to reduce the risk of infection.
- When replacing the hose, do not touch the temperature sensors. If these sensors are touched in any way, they can be damaged and out of calibration. This could cause burns to the patient. If the temperature sensors are touched or damaged, perform the after-service test protocol after replacing the hose (see Mistral-Air Warming Unit Technical Manual).
- Use of accessories, transducers and cables other than those specified or provided by The Surgical Company International B.V. of this equipment could result in increased electromagnetic emissions or decreased electromagnetic immunity of this equipment and result in improper operation.
- Do not disassemble the system unless you are a qualified service technician. This may result in injury.
- Before performing corrective maintenance (see **Corrective maintenance** on page 42), disconnect the power supply cord to eliminate the risk of electrocution. There are electrically live parts within the system when it is connected to a power supply.
- To attach the (optional) Mistral-Air QC Hose - (MA1018) or QC Hose XL - (MA1018XL, MA1018XL-QC) with a quick connector, firmly press the hose connector into the unit until a "click" is produced. Check to ensure the connector is securely locked on the system (MA1018-QC only).
- When placing the system on a surface, make sure the surface is horizontal, solid and clean. Do not place the system on a carpet because it could block the air inlet and reduce the performance.
- When using bed hooks, only mount the system to a horizontal secured surface. Do not mount the system to a tilting non-secured surface. The system may fall and pull the blanket from the patient.
- Do not place the system above, or in the bed with the patient. This may result in injury.
- Place the system in such a way that the mains plug can be disconnected easily in case of emergency. This may result in injury to the operator.
- Connect the system to an adequate reliable grounded receptacle. Operator injury may result.

- When mounted to the Mistral-Air Adjustable Pole, make sure that the hose does not extend beyond the wheelbase of the Mistral-Air Adjustable Pole so that it is protected by the wheelbase. Otherwise damage to the hose may occur.
- Clean the hose at ambient temperature and make sure the hose is dry before use. Damage to the hose or system may occur.
- When the system has suffered impact, disconnect the power plug and perform the after service test protocol before returning the system for clinical use (see Mistral-Air Warming Unit Technical Manual). Otherwise this may result in injury to the patient.
- Do not position the system close to the patient's head if inhaler therapy is used on the intensive care. This may result in injury to the patient.
- Do not modify this equipment without authorization of the manufacturer.
- In case of any serious incident in relation to the system: reporting to the manufacturer and following relevant hospital procedure for reporting to local competent authority is mandatory.
- The system and its single use items may be a potential biohazard during and after use. Handle and dispose of in accordance with accepted medical practice and applicable local regulations.
- Use of materials of good thermal conductivity, such as water, gel, and similar substances, with the system not switched on can decrease the temperature of the body of a patient.
- Do not use a warming blanket or suit that is more than 3 years old.
- Do not use sterile blanket if the EO indicator sticker is not green. See **Mistral-Air blankets and suits** on page 30.
- Do not block the inflated parts of the Mistral-Air warming blanket or suit, this may result in injury to the patient.

2.3 Cautions



Caution!

- Do not use a sharp object to press the buttons on the control panel.
- The system must be mounted securely, or placed on a stable flat surface before use to prevent the system from falling.
- To ensure stability when mounted to a trolley the system may only be mounted to a Mistral-Air Adjustable Pole (MA5200).
- Do not immerse the system in liquids. Otherwise, the system can be damaged.
- Stay in viewpoint of the control panel when the system is performing the self-test and selecting the set-point. See **Turning on the device** on page 38.
- Some Mistral-Air blankets are equipped with medical adhesive tape. Incorrect and/or unintended use adhesive tape could lead to medical adhesive-related skin injury (MARSİ).
- Information of the correct technique to be used when applying and removing adhesive products, in order to may reduce the occurrence of MARSİ can be found in **Mistral-Air blankets and suits** on page 30.
- In case of an alarm, check for any obstruction of the air flow; ensure that the blanket or suit and the hose are not folded, the inlet is free (not blocked) and no tools/equipment are placed

on the blanket. If the system continues to alarm, take the system out of use and contact the hospital service department or the local supplier.

- Do not place the system on a carpet because it could block the air inlet and reduce the performance.
- Do not pick up or move the system by pulling the power cord.
- Do not cover the patient's thorax with Mistral-Air warming blanket or suit during cardioversion or defibrillation therapy or during use of dispersive electrode pad.
- Mistral-Air blankets need to be used with the soft blue material towards the patient's skin. When used oppositely the treatment will be ineffective. The blue side provides the air distribution towards the patient.
- Adjust the temperature of the Warming Unit when the therapeutic goal is reached, or a vital sign of instability occurs (also notify the physician).
- Patients skin must be dry to avoid evaporative cooling.

2.4 Notes



- The Warming Unit does not contain an alarm system with an interruption of power supply/ supply mains alarm condition. This means that in case of a power failure, there will be no alarm.
- The Warming Unit is not equipped with an isolating switch. Temporary interruption of the supply mains will render the system in standby mode and discontinue treatment.

2.5 List of Symbols

This section contains a list of symbols used for the Mistral-Air Forced Air Warming Unit, Mistral-Air warming blankets and Mistral-Air warming suits.

IP23

Protected against ingress of solid objects larger than 12.5 mm and water falling as a spray at an angle up to 60° from the vertical axis (according to IEC 60429).



Connect the system to an earthed socket only. Risk of electrical shock exists if the equipment is not connected to a properly grounded receptacle.

No free hosing



Warning!



Hose nozzle SHALL be connected to a compatible forced air blanket or suit or thermal injury may occur.



Check patient's temperature and skin condition at least every 15 minutes, or according to institutional protocol.



Warning!

Do not use the system distal to arterial cross clamping or with a patient with an ischemic limb.



Medical Device



MOD stands for the modification update.



Serial number



Catalog / article number



Manufacturer



Transport and storage ambient temperature limits



Transport and storage relative humidity limits



Transport and storage atmospheric pressure limits



AC voltage



Type BF applied parts (according to IEC 60601-1:2005 + A1:2012 + A2:2020)



Equipotentiality



Read the user manual.



Consult the instructions for use.



CE marking of conformity including notified body number



Dispose according to European Community Directive 2012/19/EU (WEEE).



Caution. Consult the instructions for use for important cautionary.



Low priority alarm indication on control equipment



Medium priority alarm indication on control equipment



Temporarily audible alarm suppression



Repair is required



Upper limit of temperature, overtemperature alarm



Replace filter



Air flow at ambient temperature (not heated)

32°C / 89.6°F

Air flow setpoint at a temperature of 32°C / 89.6°F (heated)

38°C / 100.4°F

Air flow setpoint at a temperature of 38°C / 100.4°F (heated)

43°C / 109.4°F

Air flow setpoint at a temperature of 43°C / 109.4°F (heated)

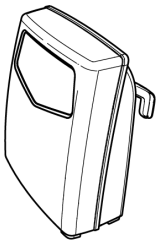

Prior to use, the user needs to check that the system (including the power cord and the hose) is undamaged. In the event of damage do not use the system.



Maintenance may be only performed by trained biomedical technicians or engineers only. Both user groups must be trained by certified trainers from The Surgical Company International B.V. or by certified business partners of The Surgical Company International B.V..

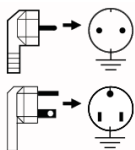

Warning!

Plug the system into an earthed mains socket.

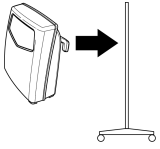

Before using the system, it should be attached to a pole, Mistral-Air Adjustable Pole (MA5200), bed rail/end, ISO rail, wall, or placed on a table.



Not for use in magnetic resonance imaging (MRI)



Caution: Federal US law restricts this system to sale by or on order of a physician.



Do not use the system if the package is damaged and consult instruction for use.



Quantity of systems per box, pouch or packaging unit



Sterile, method of sterilisation ethylene oxide



NON STERILE: Product is non sterile, an identical or similar sterile medical system is also available.



Batch code / lot number



S = Small, M = Medium, L = Large, XL = Extra large



Keep dry.



Keep away from sunlight.



Manufacturing date



Blue side to patient



Expiry date, year/month



For single patient use only. Do not re-use.



UL mark to that the product has been tested and certified by Underwriters laboratories. Applicable to MA1200-US only.

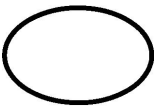

Single sterile barrier



Not made with natural rubber latex



Neonate under 1 year old



Pediatric over 1 year old



Read the user manual.



CE marking of conformity (Class I self-Certified)



Caution. Consult the instructions for use for important cautionary.

3 Description

The Mistral-Air Warming Unit is a Forced Air Warming Unit which consists of a fan, heater, electronics and a filter to propel filtered and heated air to a blanket or suit. The device is available in two models: MA1200 equipped with a fixed hose, and MA1200 equipped with a removable hose.

The device can be controlled by using the control panel at the front top of the device. The back of the device is equipped with a universal mounting clamp, a sealed data connector, an appliance inlet and an equipotential pin. The air flow output is by default set to normal and can be adjusted by the technical department to a low fan duty cycle, resulting in 10% lower air flow output. It can be expanded with a mounting accessory set to offer various mounting options, see **Single-use items, accessories and spare parts**. on page 26.

The device shall only be used with single-use Mistral-Air single use blankets.

3.1 Overview of the Mistral-Air Warming Unit MA1200

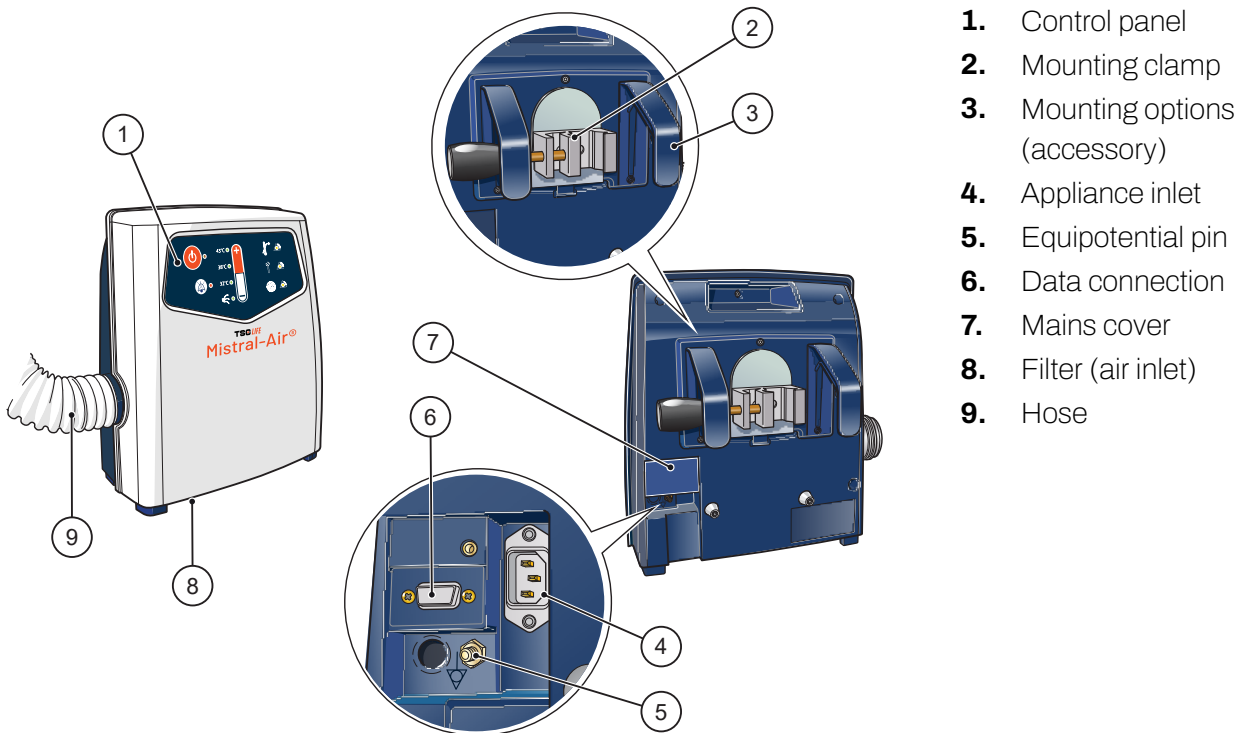

For more device specifications, see **Specifications** on page 51.

3.2 Overview of the Mistral-Air Warming Unit MA1200-QC

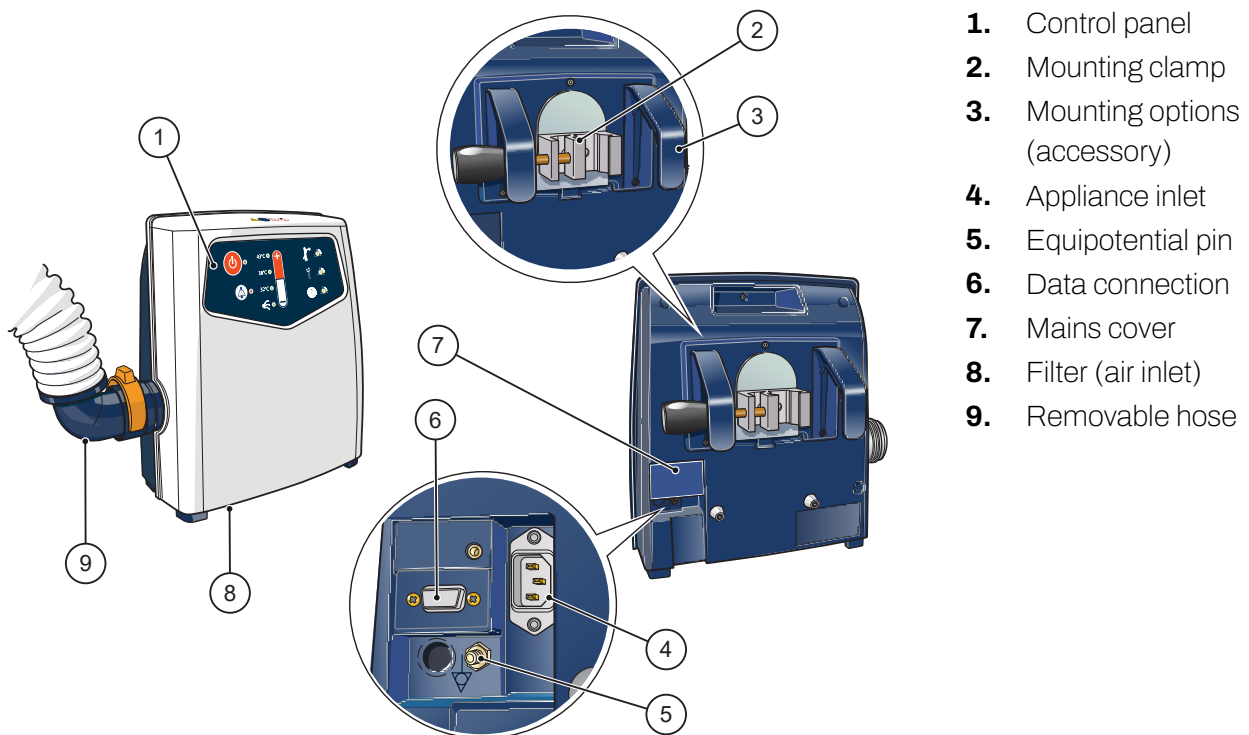

For more device specifications, see *Specifications* on page 51.

3.3 Overview of the control panel

The control panel is located at the front top of the device and can be operated by pressure sensitive buttons. The device is easy to use. All settings are visible on the control panel and you can select the preferred temperature by pressing the temperature selection buttons. The temperature selected is or will be the temperature in the blanket or suit. When an alarm condition is detected, an audible alarm will be activated and an alarm LED will flash yellow.

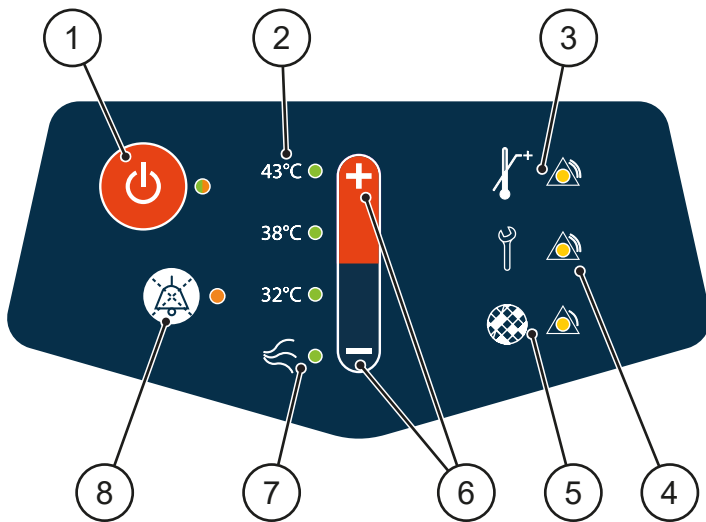

1. Standby button
2. Temperature selection indicators
3. Overtemperature alarm LED
4. Technical alarm LED
5. Filter replacement indicator LED
6. Temperature selection + and – buttons
7. Fan only/ambient air indicator
8. Temporarily audible alarm suppression button

3.4 Visual and audible warning systems

The device is equipped with visual and audible warning systems to protect against excessive temperatures, to warn for a technical malfunction, and to indicate that filter change is required.

If equipment errors occur, an audible alarm sounds and the relevant LED indicator(s) on the control panel will flash or light up continuously.

There are four different alarms/indicators:

- Technical alarm
- Overtemperature alarm
- Microcontroller watchdog alarm
- Filter replacement indicator

These alarms/indicators are described in the sections below. It is also possible to temporarily suppress the audible alarm.

Alarm/indicator summary

Alarm/indicator	Priority	Behavior
Technical alarm	Medium	Technical alarm LED: Yellow flashing Audible alarm: 3 beeps repeated every 6 seconds
Overtemperature alarm	Medium	Technical alarm LED: Yellow flashing Overtemperature alarm LED: Yellow flashing Audible alarm: 3 beeps repeated every 6 seconds
Microcontroller watchdog alarm	Medium	Technical alarm LED: Yellow continuous Overtemperature alarm LED: Yellow flashing Audible alarm: continuous beep
Filter replacement indicator	Low	Filter replacement indicator LED: Yellow continuous Audible alarm: 1 short beep

3.4.1 Technical alarm

A flashing yellow technical alarm LED indicates that a technical error has occurred and the air temperature cannot be accurately controlled. The visual alarm is accompanied by an audible alarm, which consists of three pulses of 200 ms duration, with 200 ms spacing between each pulse. This pattern is repeated every 6 seconds.

Some possible causes of this alarm:

- The leads to the temperature sensors are damaged, or disconnected.
- The fan is blocked, or damaged and cannot reach its desired speed.
- The heater is damaged and the desired air temperature is not reached.
- A mains power dip ($\geq 30\%$) occurred for more than 1/60 seconds.

If this alarm occurs, the heater and fan are turned off and the device enters standby mode. It is impossible to start the device by pushing the standby button. Control of the device can only be recovered through resetting the device. To do this, disconnect the mains plug and reconnect it.



Caution!

If this alarm occurs, check for anything blocking the air flow path. If the technical alarm continues, take the device out of use and contact the hospital service department or the local supplier.

3.4.2 Overtemperature alarm

The overtemperature alarm is triggered with a maximum air temperature of 56°C / 133°F.

When the overtemperature alarm occurs, the technical and overtemperature LED's flash yellow. These indicate that the air temperature is too high. The visual alarms are accompanied by an audible alarm, which consists of three pulses of 200 ms duration, with 200 ms spacing between each pulse. This pattern is repeated every 6 seconds.

If this alarm occurs, the heater and fan are turned off and the device enters standby mode. It is impossible to start the device by pushing the standby button. Control of the device can only be recovered through resetting the device. To do this, disconnect the mains plug and reconnect it.



Caution!

If this alarm occurs, check for anything blocking the air flow path. Ensure that the blanket is not folded and do not place tools/equipment on the blanket which could result in a blocked air flow. Ensure that the air inlet is free. If the overtemperature alarm continues, take the device out of use and contact the hospital service department or the local supplier.

3.4.3 Microcontroller watchdog alarm

The microcontroller watchdog alarm is visually indicated by a continuous yellow technical alarm LED and a flashing yellow overtemperature LED. The visual alarms are accompanied by a continuous single tone audible alarm.

The microcontroller watchdog alarm indicates a technical malfunction and is triggered when the microcontroller is not functioning properly. If this alarm occurs, the heater and fan are turned off and the device enters standby mode. It is impossible to start the device by pushing the standby button. Control of the device can only be recovered through resetting the device. To do this, disconnect the mains plug and reconnect it.



Caution!

If this alarm occurs, send the device to a certified service department for technical support.

3.4.4 Filter replacement indicator

When the yellow filter replacement LED lights up, the filter needs to be replaced. This LED is activated when the device has been used for more than 2000 hours. When it is activated, it is accompanied by a single beep.

Refer to *Replacing the Mistral-Air Filter (MA1200-1001)* on page 42 for the filter replacement procedure.

3.4.5 Temporarily audible alarm suppression

The audible alarm may be suppressed for up to 2 minutes by pressing the temporarily audible alarm suppression button.

When the audible alarm is suppressed, the orange LED lights up. After 2 minutes or after pushing the button once again, the audible alarm will automatically be restored.

4 For Use With



Warning!

Only use TSC Life - approved devices, unless otherwise specified.

The device listed in *Single-use items, accessories and spare parts.* on page 26 identifies TSC Life approved devices intended to be used with the Mistral Air Warming Unit to obtain a safe combination.

5 Single-use items, accessories and spare parts.

The device shall be used exclusively with Mistral-Air Blankets and Suits. Furthermore, it is to be used only with the following accessories, warming blankets and suits and spare parts.

- Mistral-Air Adjustable Pole (MA5200)
- Mistral-Air MA1200 Mounting Parts (MA5002)
- Mistral-Air MA1200- Hose XL (MA1018XL)
- Mistral-Air MA1200 -Hose (MA1018)
- Mistral-Air MA1200 - Filter (MA1200-1001)
- Mistral-Air Hoseclamp (MA5001)
- Mistral-Air MA1200 - Hose XL (MA1018XL)
- Mistral-Air MA1200 - Hose (MA1018)
- Mistral-Air Blankets Plus
- Mistral-Air Blankets Plus Sterile
- Mistral-Air Premium Blankets
- Mistral-Air Warming Suits
- Mistral-Air Premium Warming Suits



Warning!

- Do not place the system above, or in the bed with the patient. This may result in injury.
- When placing the system on a surface, make sure the surface is horizontal, solid and clean. Do not place the system on a carpet because it could block the air inlet and reduce the performance.
- The system must be mounted securely, or placed on a stable flat surface before use to prevent the system from falling.
- To prevent tipping when mounting to an IV-pole, mount the system at a height at which the IV-pole is stable. If the IV-pole is unstable, injury may occur. Before usage, assess the stability by placing the IV-pole on a surface at an angle of 10° from the horizontal plane with brakes activated. The IV-pole may not overbalance, or move. Also passing over a 10 mm / 0.39 in. threshold may not result in overbalancing. Mass and position of center of gravity are provided in this IFU for theoretical analysis. The Surgical Company International B.V. cannot provide maximum mounting height prescriptions for different wheel base diameters, numbers of castors (either with brakes or not) and configurations of other equipment mounted to the IV pole.

The image below shows the position of the center of gravity in relation to the center of the pole clamp.

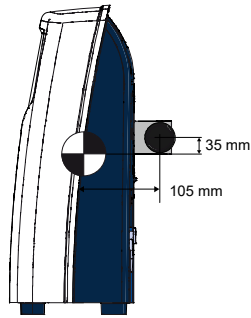

In the standard configuration, the device can be mounted to an IV pole or ISO rail using the universal clamp on the back of the device (see figures below). It is also possible to place the device on a table without reducing the air flow rate.

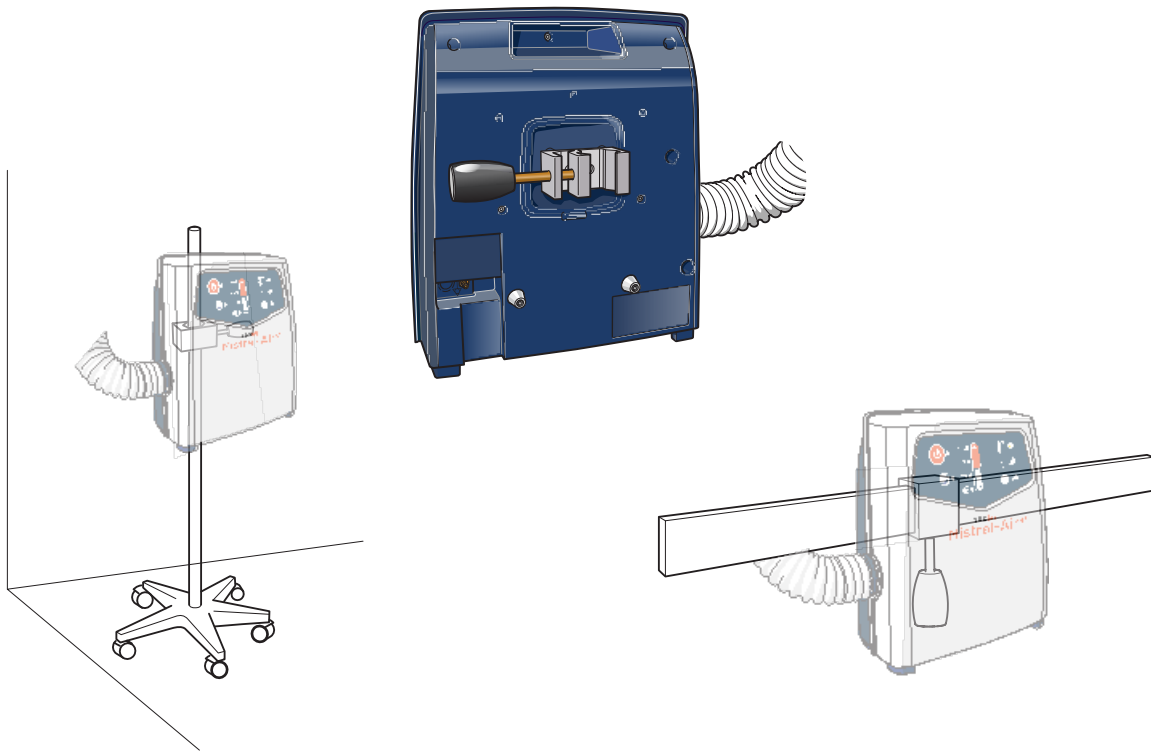

5.1 Mistral-Air Adjustable Pole (MA5200)



Caution!

When mounting the device to the Mistral-Air Adjustable Pole, make sure that the hose is protected by the wheelbase of the trolley. Otherwise, damage to the hose may occur after impact.

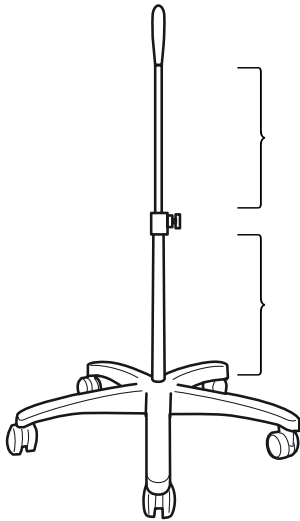
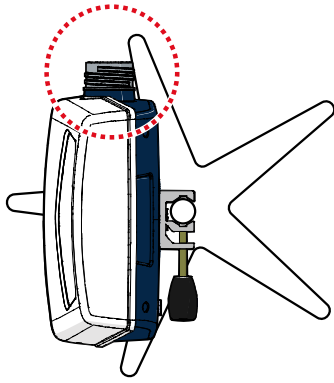

Warning!

Do not mount the device on the extendable, smaller diameter, part of the trolley's pole. Only mount the device on the non-extendable part of the trolley's pole (the lower part).

Mount the device here.

The device can be mounted onto the Mistral-Air Adjustable Pole (MA5200):

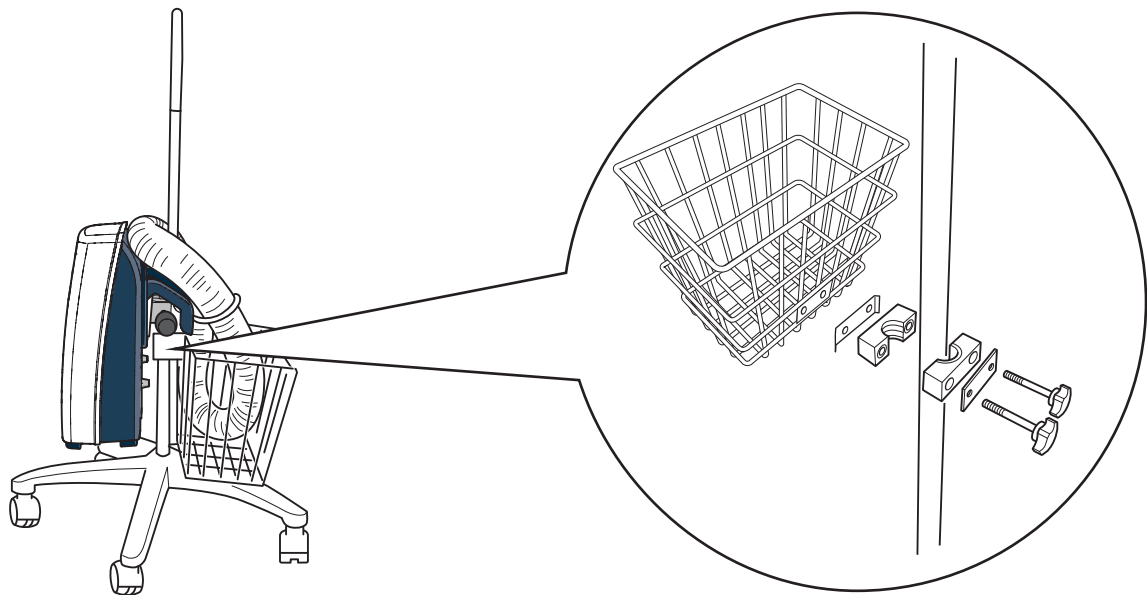

5.2 Mistral-Air MA1200 - Mounting Parts



Warning!

- When using bed hooks, only mount the system to a horizontal secured surface. Do not mount the system to a tilting non-secured surface. The system may fall and pull the blanket from the patient.

The device has various mounting options using the versatile Mistral-Air mounting accessory set.

See *Attaching the mounting parts* on page 34 for more details about attaching the mounting parts.

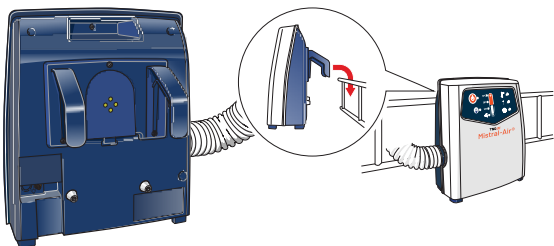
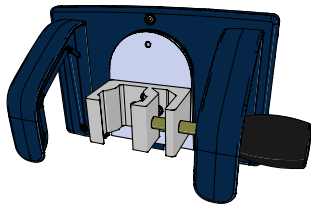

Mounting on a bed rail/end using the bed hooks.

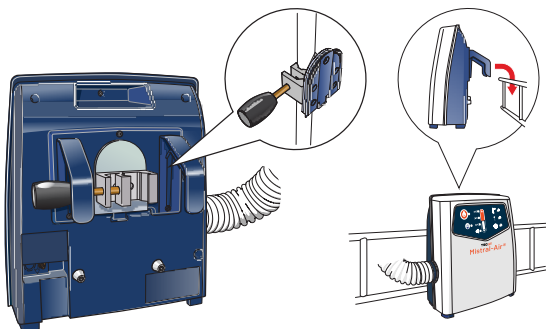

Quick-release mechanism to switch between mounting to bed rail/end and pole.

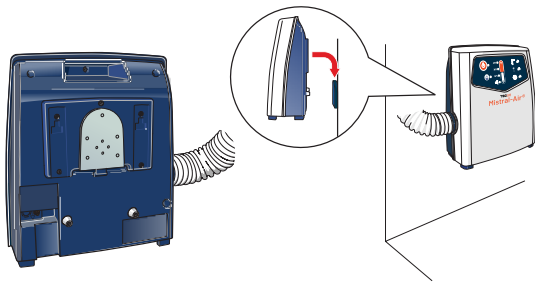

Mounting on a wall using the Wall mount. Release by using the quick-release mechanism.

5.3 Mistral-Air QC Hose - (MA1018-QC) and QC Hose XL (MA1018XL-QC)

The Mistral-Air Warming Unit MA1200-QC has quick-connect functionality to easily replace hoses. Two types of QC (Quick Connect) hoses are available:

- QC Hose - (MA1018); 1.8m / 71 in. hose length
- QC Hose XL - (MA1018XL); 3m / 118 in. hose length



5.4 Mistral-Air blankets and suits

The Mistral-Air Blanket range consists of the following categories:

- Mistral-Air Blankets Plus
- Mistral-Air Blankets Plus Sterile
- Mistral-Air Premium Blankets
- Mistral-Air Warming Suits
- Mistral-Air Premium Warming Suits

Please refer to the instructions for use (IFU) (INT/R709-WO/x-xx/xx Mistral-Air Blankets) and (INT/R917-WO/x-xx/xx Mistral-Air Suits) or the website of The Surgical Company International B.V. (www.tsc-life.com) for a description of the individual blankets and suits. The blankets and suits have a shelf life of 3 years.

Sterile blankets EO indicator

The pouch and box label of each sterile blanket is equipped with an EO indicator sticker. This indicator changes color from violet to green when the product has been sterilized with ethylene oxide (EO) gas. If the indicator is not green, then the product must not be used (See warning in **Warnings** on page 9.).



Label with green EO indicator sticker. This product has been sterilized and can be used.



Label with a violet EO indicator sticker. This product has not been sterilized and shall not be used.

Medical adhesive-related skin injury (MARSİ)

Some Mistral-Air blankets and suits are equipped with medical adhesive tape. Incorrect and/or unintended use adhesive tape could lead to medical adhesive-related skin injury (MARSİ). Information of the correct technique to be used when applying and removing adhesive products, in order to reduce the occurrence of MARSİ.

MARSI is defined as damage to the skin that may occur when superficial layers of skin are removed using medical adhesive, resulting in skin trauma or an adverse skin reaction, including formation of vesicles, bullae, skin erosion and skin tears. In order to be defined as MARSI, the injury must persist for longer than 30 minutes after removal of the adhesive. MARSI not only affects the integrity of the skin but it also causes pain, increases the risk of infection and potentially increases wound size and healing time.

This manual emphasizes the warnings and cautions relating to MARSI and lists ways to minimize/prevent the occurrence of MARSI when applying and removing adhesive tape used with Mistral-Air Warming Blankets.



Warning!

- Do not use on open wounds;
- Do not use on fragile/easily damaged skin (thin skin, age-related dermal fragility, etc);
- Do not use on premature/dysmature infants/neonates;
- Only apply adhesive/tape to completely dry skin;
- Only apply adhesive/tape to intact/healthy skin;
- Do not pull the skin up when removing the adhesive.



Caution!

- When using the adhesive on patients who have been exposed to moisture for prolonged periods;
- When using on patients when repeatedly removing tape/dressing/device;
- When using adhesive on patients taking certain medications such as anti-inflammatory agents, anticoagulants or chemotherapeutic agents, or patients with long-term use of corticosteroids and radiation therapy;
- When using on patients with reduced skin vascularity/elasticity and tensile strength;
- When using on patients with chronic skin conditions such as eczema, dermatitis, chronic ulcers and epidermolysis bullosa;
- When using on patients who have a history of sensitivity or suspected allergies to adhesive applications;
- When using on patients who have a history of sensitivity or suspected allergies to adhesive applications;
- When using on patients diagnosed with malnutrition or dehydration;
- When using on patients with photodamage;
- When using disinfectants that contain oil or glycerin, or disinfectant that leaves a film(these may impair adhesion).

The instructions for use in application and removal to minimize the risk of MARSI when using Mistral-Air Warming Blankets with adhesive tape:

- 1.** Pre-OR skin treatment according to hospital procedure;
- 2.** Assess the skin before applying the adhesive;
- 3.** Dry the skin or let it dry at and around the tape application area;
- 4.** Remove the release liner using the finger lift;

5. Apply the blanket free of wrinkles to the skin and press firmly to increase anchorage. The anchorage of the tape is improved by the heat of the skin.

Additionally

- Avoid gaps and wrinkles which may allow moisture/solutions to intrude between the tape and the skin during application;
- Do not use alcohol-based skin preps, which are drying to the skin;
- Trim hair prior to application;
- Do not overuse products that increase the stickiness of the adhesive (i.e. tackifiers, bonding agents);
- Do not pull/stretch the tape during application, to prevent tension during application;
- Do not touch the adhesive side prior to application (this may reduce the adhesion).

Removal

1. Loosen the edge of the tape;
2. Stabilize the skin by placing one finger next to the peel line in order to support the skin and prevent it from being stretched/pulled;
3. Remove the tape from the skin carefully, close to the skin and using a movement parallel to the skin (180°) and in the direction of hair growth (slow and low), pulling the tape back over itself;
4. Remove the release liner using the finger lift;

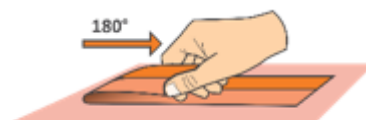

In some cases, there may be some side-effects when using medical adhesives:

- Some of the tape may remain on the skin after removing the Warming Blanket;
- Skin may be red and rough after removal. Redness should disappear within 30 minutes.

6 Installation

6.1 Transport and storage

Store the device and accessories according to the transport and storage recommendations. See *Specifications* on page 51.

6.2 Connecting the power supply cord

1. Remove the mains cover using a 4 mm hex key.
2. Attach the C13 plug of the power supply cord.
3. Reattach the mains cover to lock the C13 plug by tightening the 4 mm hex screw with a maximum torque of 1.5 ± 0.2 Nm.

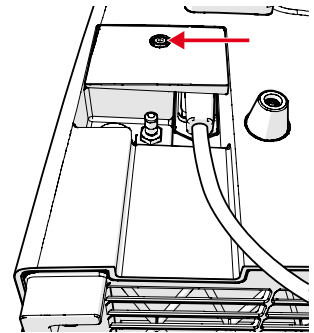

6.3 Attaching the mounting parts

The MA1200 mounting parts set consists of the following parts:

- 1x Wall mount
- 1x Cover
- 2x Handle
- 1x Cover plate
- 2x Bed support knobs
- 5x M6 x 6 Button head 4 mm hexagon screw
- 5x M4 x 16 Low Cylindrical head 3 mm hexagon screw
- 2x DELTA PT Torx 20IP screw 40 x 16



Caution!

Be careful not to scratch the front of the device.

1. Disconnect the device from the mains socket.
2. Place the device face-down on a soft surface.

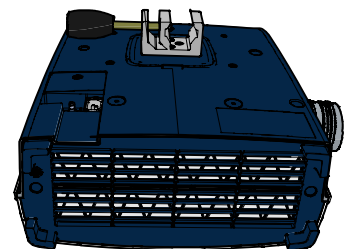

3. Remove the 4 M5 screws of the pole clamp using a 4 mm hexagon key and remove the pole clamp.

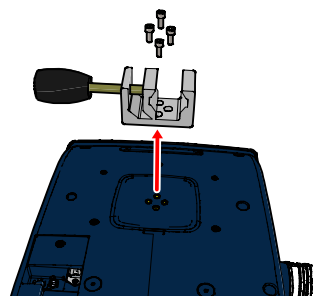

4. Attach the Cover at the 3 indicated locations using the first 3 of the 5 M4x16 3 mm hexagon screws with a maximum torque of 1.5 ± 0.2 Nm.

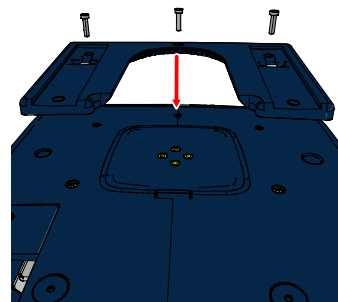

If you do not attach the Handles mentioned in the step below, you still need to tighten the last 2 of the 5 M4x16 3 mm hexagon screws.

5. Optional: Click the Handles into the sliders of the Cover and tighten them at the 2 indicated locations using the last 2 of the 5 M4x16 3 mm hexagon screws.

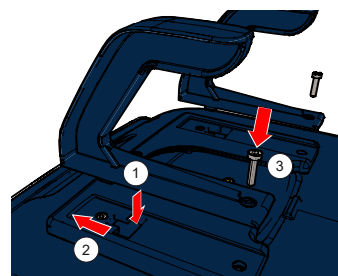

Warning!

If the Handles are attached, always attach the Bed support knobs for stability (see step 6).

6. Optional: Attach the 2 Bed support knobs using the 2 Torx screws. Tighten the screws until the Bed support knobs cannot be rotated anymore.

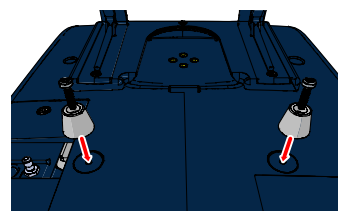

7. Optional: Mount the Wall mount and Cover plate to a wall using wall screws and plugs specifically designed for the used wall material (not supplied). First check the adequacy (of the surface) of the structure to which the wall mount will be attached based on the mass of the device (see **Specifications of the device** on page 51) and the center of gravity shown below.

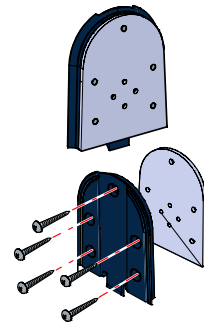

Caution!

Use screws with a diameter which is small enough (max. M6) not to damage the threads of the Cover plate holes.



It is advised to account for the readability of the control panel when deciding about the mounting height.

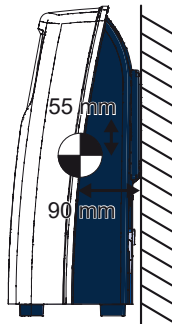

8. Optional: Attach the Cover plate to the Wall mount using the 5 M6x6 4 mm hexagon screws. And attach the pole clamp to the Cover plate using the 4 M5 screws which were removed during step 3 using a 4 mm hexagon key.

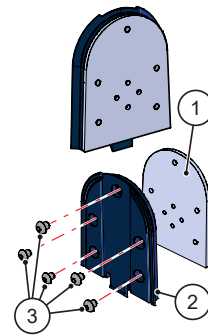
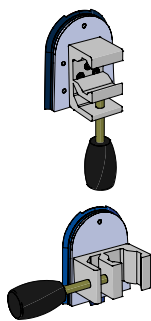

7 Operation

7.1 Safety instructions before operation



Warning!

When using the device, first read the warnings in **Warnings** on page 9.

The device is intended to be used only by trained clinicians. Intended patient population: adults and pediatric patients.

The clinical areas are: operating room, recovery room, anaesthetic room, intensive care unit, medical/ surgical floors and emergency room. Mainly used during the entire perioperative pathway (pre-, per-, and postoperative period).

7.2 Cybersecurity

The device contains firmware and is only intended to be connected to external software during servicing. During intended use, the system is used 'stand-alone' without (attainable) external connections. The device cannot be connected to any other devices during use with a patient. During intended use there is minimal risk of cybersecurity threats. To protect the essential performance of the device, it is equipped with two independent circuits, where the safety controller serves as secondary safety mechanism. The output and safety temperature output are compared to match. Various thermometers control or detect the device temperature on various locations. If the device is out of specification errors are triggered.

7.3 Connecting the Mistral-Air QC Hose (MA1200-1018 & MA1200-1018XL) to the device

1. Check the QC Hose or QC Hose XL for damage.
2. Hold on to the front-end hose connector (knee part).
3. Place the front-end of the hose into the quick connector.
4. Press the connector firmly into the blower until a "click" is produced.
5. Check to ensure the hose is firmly connected.

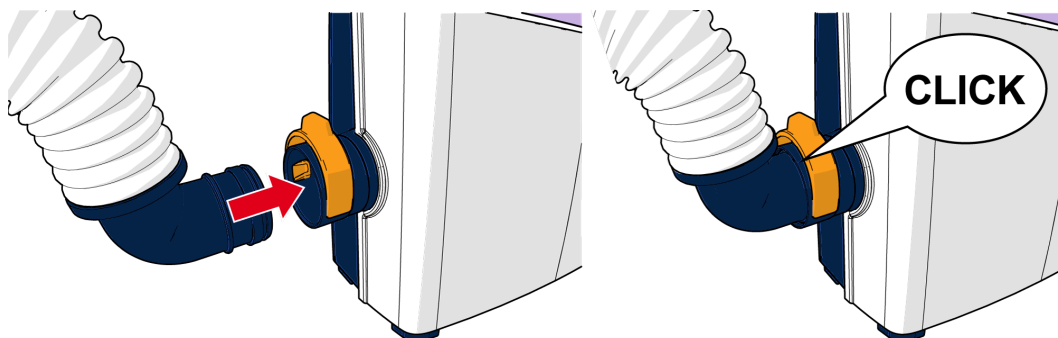



The QC Hose can be rotated 360° for optimal range.

7.4 Connecting the power supply



See *Connecting the power supply cord* on page 34 if the power supply cord is not yet connected to the device.

1. Plug the device into an earthed mains socket.
2. The device automatically switches to the standby mode, which is indicated by the orange standby LED located on the left side of the control panel.

7.5 Connecting the blanket

1. Take the selected Mistral-Air blanket out of the package and follow the instructions on the insert provided with the blanket box.
2. Place the unit near the hose inlet of the blanket.
3. Insert the end of the flexible hose into the air inlet port of the Mistral-Air blanket.
4. Check if the hose is fully pushed in.

7.6 Turning on the device



Caution!

Stay in viewpoint of the control panel when the device is performing the self-test and selecting the set-point.

1. Activate the device by pressing the standby button. The LED turns green.
2. The device will now perform a self-test, which includes a flash of all the LED's and a short beep. When a LED or the audible beep fails, take the device out of use for repair.
3. After the self-test, which lasts several seconds, the device will start blowing air at the default temperature setting of 38°C / 100.4°F.

7.7 Selecting the temperature

The description of the setpoints corresponds to the average temperature under the blanket. There are four temperature setpoints:

- Fan only/ambient air: Ambient air temperature. The air temperature to the patient will depend on ambient conditions and possible heat from the fan motor.
- 32°C / 89.6°F: Low temperature.
- 38°C / 100.4°F: Medium temperature.
- 43°C / 109.4°F: High temperature.

The selected temperature is indicated by one of four green temperature selection indicator LED's, see *Overview of the control panel* on page 20.

1. After the self-test, the device will start blowing air at the default temperature setting of 38°C / 100.4°F.
2. Press the – button twice to deactivate the heater. The fan only/ambient air indicator turns green and air at ambient temperature is blown to the patient.
3. Press the + button to activate the heater.
4. Press the + button multiple times to increase the air temperature at the blanket to a setpoint of 38°C / 100.4°F, or 43°C / 109.4°F.
5. Press the – button to decrease the temperature setpoint.

After selecting the desired temperature, the LED next to the temperature indicator symbol will flash green. After reaching the set temperature (+/- 2°C / 3.6°F), the green LED lights up continuously.

7.8 Stopping warming

1. Press the standby button.
2. Disconnect the hose from the blanket.
3. If desired, leave the blanket on/under the patient.
4. If desired, replace the QC Hose (only for MA1200-QC).

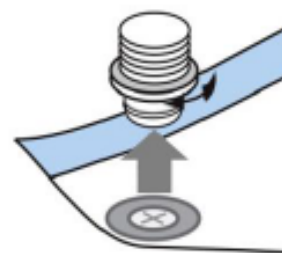

Caution!

To remove all power from the device, the mains power cord must be removed from the electrical receptacle.

8 Maintenance



Warning!

- Maintenance may only be performed by trained biomedical technicians or engineers. Both user groups must be trained by certified trainers from The Surgical Company International B.V..
- Preventive maintenance needs to be performed on an annual basis. Please refer to the Mistral-Air technical manual for maintenance, repair and calibration instructions. The Mistral-Air technical manual is available for download at the business partner menu of the The Surgical Company International B.V. website.



Caution!

Clinical users may not repair or open the device in the event of a malfunction. This can damage the appliance and will invalidate the warranty.

Have the device serial number ready when you contact the hospital service department or the local supplier for technical support. The serial number is located on the label on the back of the device.

Before performing maintenance, consult the device insulation diagram below.

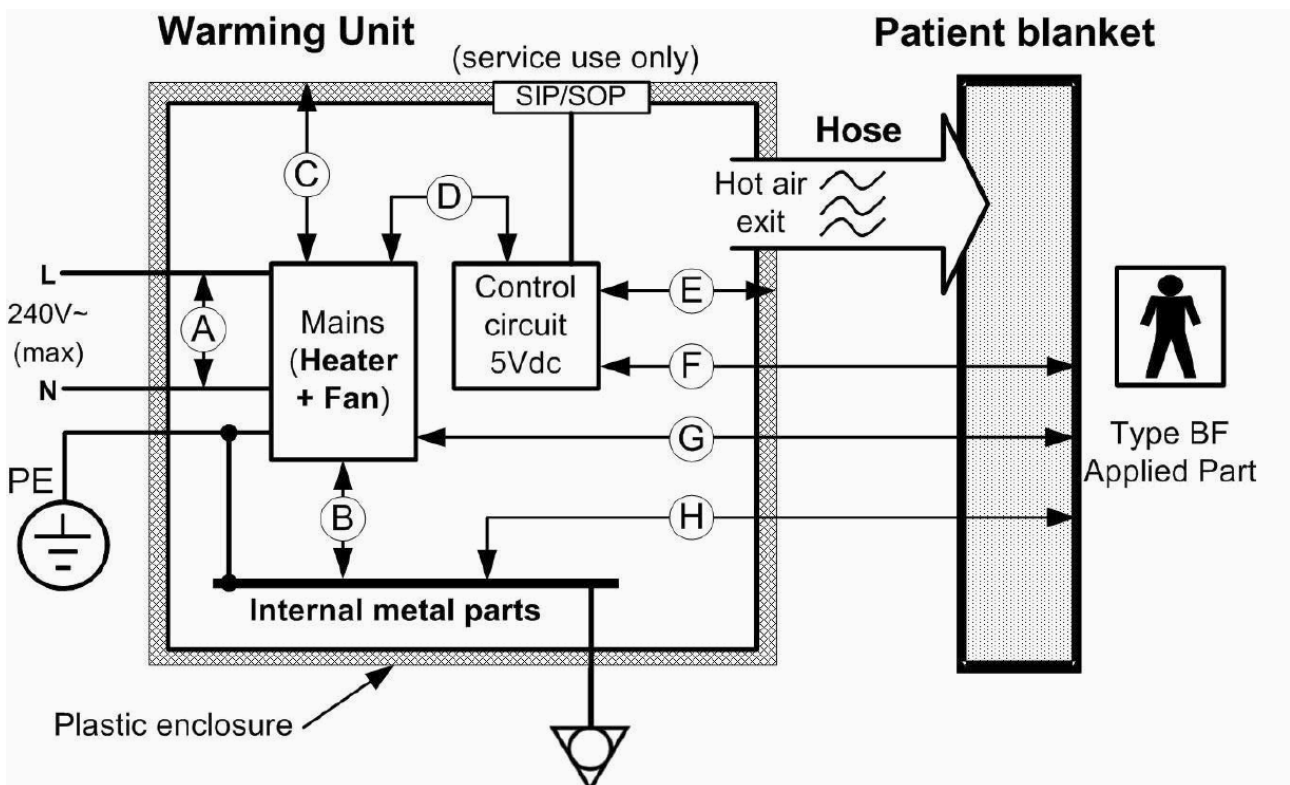

8.1 Cleaning



Warning!

- Before you clean the system, disconnect the power supply cord to eliminate the risk of electrocution.
- Do not use dripping wet cloths.
- Do not use ketones (MEK, acetone, etc.) or abrasive cleaners.
- Do not use alcohol based cleaners (except isopropyl alcohol and ethanol).
- Do not use acid based cleaners.
- Do not use oxidizing cleaners.
- Do not exceed the concentration specified by the manufacturer; or use premixed solutions.
- Do not use steam sterilization (autoclave) or dry heat to sterilize the device.
- Do not immerse the system in liquids. Otherwise, the system can be damaged.
- Make sure that fluids cannot enter the electrical areas of the device.
- Do not place the device upside down, or on its sides.
- Clean the hose at ambient temperature and make sure the hose is dry before use. Damage to the hose or device may occur.

If desired, remove the QC Hose for cleaning or replacement before cleaning the device (only for MA1200-QC).

After each use, clean all exterior surfaces of the reusable components according to the following validated cleaning procedure:

1. Visually inspect the components to ensure there is no visible damage or deterioration of the enclosures such as cracks, or deterioration of the labels and power cord. Do not clean if there is a defect and contact The Surgical Company International B.V. or your local distributor.
2. Immerse a soft cloth or sponge as an applicator into the cleaning solution consisting of mild liquid detergent soap and warm tap water mixture. Squeeze out excess solution so that the applicator is not dripping. Wipe or scrub the entire surface of the enclosure and control panels thoroughly. Use a soft brush with cleaning solution to clean the power cord if necessary.
3. To remove dried blood, clean with 3% hydrogen peroxide or water diluted chlorine bleach (30 ml/l) with a soft cloth.
4. Rinse a separate soft cloth or sponge in room temperature tap water. Squeeze out excess water so that the applicator is not dripping. Wipe all of the aforementioned surfaces thoroughly. Repeat rinsing the cloth or sponge several times with fresh running water during this process to ensure all visible detergent residue is removed from the device.
5. Dry the item with a hand towel or soft cloth.
6. Visually inspect all components to ensure that they have been thoroughly cleaned. Repeat cleaning procedure if necessary.

After thoroughly cleaning all exterior surfaces of the reusable components, perform disinfection according to the validated disinfection procedure described in **Disinfection** on page 42.

8.2 Disinfection

Disinfect the device only after conducting the cleaning procedure as described in *Cleaning* on page 41.

Disinfection is a procedure for removing (biological) contaminations.

1. Disinfect all exterior surfaces of the reusable components with one of the following disinfectants, which can be safely used without causing damage to the enclosure:
 - 70% ethyl alcohol (ethanol) based disinfectants. Contact time \geq 7 min.
 - 70% isopropyl alcohol (isopropanol) based disinfectants. Contact time \geq 7 min.

Refer to the disinfectant instructions for use, including the application and method.

2. After thoroughly disinfecting, rinse a soft cloth or sponge in room temperature tap water. Squeeze out excess water so that the applicator is not dripping. Wipe all surfaces thoroughly to remove residual disinfectant.
3. Dry the item with a hand towel or soft cloth.
4. Store the clean device in a non-contaminated area when not in use.

8.3 Corrective maintenance



Warning!

Maintenance may only be performed by trained biomedical technicians or engineers. Both user groups must be trained by certified trainers from The Surgical Company International B.V..

8.3.1 Replacing the Mistral-Air Filter (MA1200-1001)

The accumulation of dust in the air filter will reduce the efficiency of the device. The filter must be replaced when the Filter Replacement indicator is activated, or when indicated by visual inspection. Only use parts provided by The Surgical Company International B.V. or your local distributor.



Warning!

- Do not return the device from service without the filter present.
- Before performing a repair, disconnect the power supply cord to eliminate the risk of electrocution. There are electrically live parts within the device when it is connected to a power supply.
- The filter may be a potential biohazard during and after use. Dispose of the filter with other biohazardous medical waste, in closed bins and sent for medical burn waste according to local regulations. Handle in accordance with applicable hospital procedures.



Caution!

Be careful not to scratch the front of the device.

1. Place the device face-down on a soft surface.
2. Disconnect the device from the mains socket.
3. Remove the two screws of the filter cap with a 4 mm hex key.

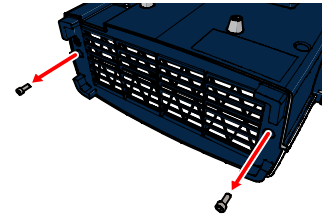
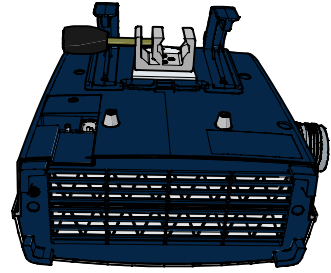

4. Remove the filter cap.

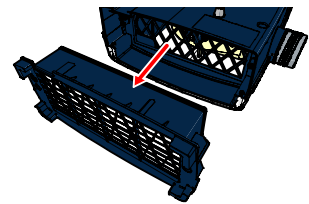

5. Remove the filter.

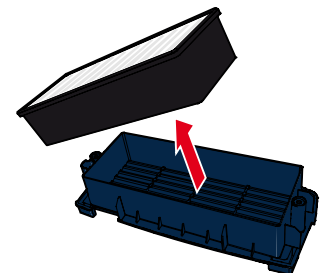

6. Place the replacement filter in the filter cap with the rubber seal facing up.

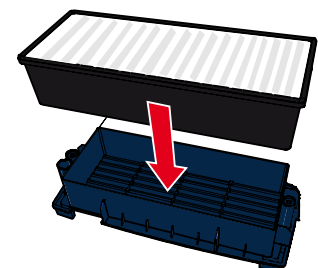

7. Place back the filter cap.

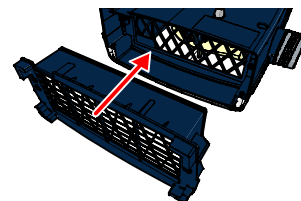

8. Place back the screws and tighten them with a maximum torque of 2.1 ± 0.2 Nm.

9. Connect the power plug to the wall socket and leave the device in standby mode.

10. Press and hold the -, + and the alarm suppression buttons simultaneously.

11. While holding down the three buttons, press the standby button.

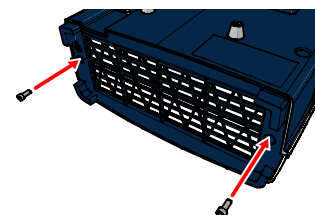

You will hear a beep and the device returns to standby mode, indicating that the Filter timer has been reset.

12. Dispose of the filter with other biohazardous medical waste, in closed bins and sent for medical burn waste according to local regulations.

8.3.2 Replacing the Mistral-Air Hose (MA1018 & MA1018XL)



Warning!

- When replacing the hose, do not touch the temperature sensors. If these sensors are touched in any way, they can be damaged and out of calibration. This could cause burns to the patient. If the temperature sensors are touched or damaged, perform the after-service test protocol after replacing the hose (see Mistral-Air Warming Unit Technical Manual).
- Before performing corrective maintenance (see **Corrective maintenance** on page 42), disconnect the power supply cord to eliminate the risk of electrocution. There are electrically live parts within the system when it is connected to a power supply.
- The Hose may be a potential biohazard during and after use. Dispose of the Hose with other biohazardous medical waste, in closed bins and sent for medical burn waste according to local regulations. Handle in accordance with applicable hospital procedures.
- Do not use dripping wet cloths.
- Do not exceed the concentration specified by the manufacturer; or use premixed solutions.
- Do not immerse the device in liquids. Otherwise, the device can be damaged.
- Make sure that fluids cannot enter the electrical areas of the device.
- Do not use alcohol based cleaners (except isopropyl alcohol and ethanol).
- Do not use acid based cleaners.
- Do not use oxidizing cleaners.

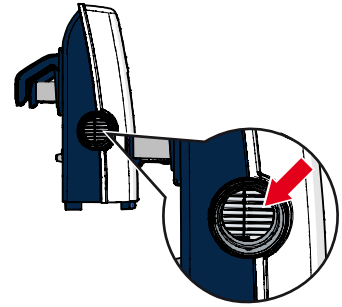

Changing the 1.8 m / 71 in. long hose for a 3 m / 118 in. long hose reduces the temperature of the air transferred to the patient with at least 1.9 °C / 3.5°F.



Caution!

Be careful not to scratch the front of the device.

1. Disconnect the device from the mains socket.
2. Place the device face-down on a soft surface.
3. Unscrew the screw that fixes the hose to the device connector.

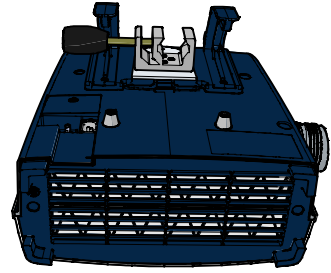

4. Unscrew the hose by rotating it clockwise or cut the hose around the soft material until both parts only held together by the wire and cut the wire with cutting pliers.

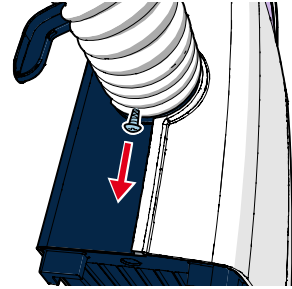

5. Spray lubricant on the inside of the new hose-end, where the device connector will be screwed on. Types of lubricant:

- Silicon spray, medical grade
- Cleaning solution of mild liquid detergent soap and tap water

6. Attach a new hose by rotating the hose anti-clockwise until the hose reaches the end of the device connector, making sure to cover the connector beyond the screw hole located in the connector.

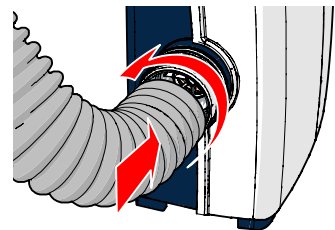
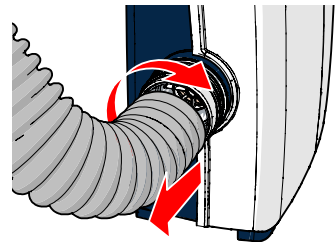

7. Pierce the hose with a sharp object at the location where the screw must be attached. Apply and tighten the screw that fixes the hose.

8. Dispose of the hose with other biohazardous medical waste, in closed bins and sent for medical burn waste according to local regulations.

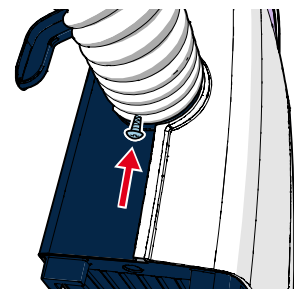

8.3.3 Replacing the Mistral-Air QC Hose (MA1018 & MA1018XL)



Warning!

Before performing corrective maintenance (see *Corrective maintenance* on page 42), disconnect the power supply cord to eliminate the risk of electrocution. There are electrically live parts within the device when it is connected to a power supply.

The QC Hose may be a potential biohazard during and after use. Dispose of the QC Hose with other biohazardous medical waste, in closed bins and sent for medical burn waste according to local regulations. Handle in accordance with applicable hospital procedures.



Caution!

Be careful not to scratch the front of the device.



Changing the 1.8 m / 71 in. long hose for a 3 m / 118 in. long hose reduces the temperature of the air transferred to the patient with at least 1.9 °C / 3.5°F.

1. Disconnect the device from the mains socket.
2. Place the device upright.

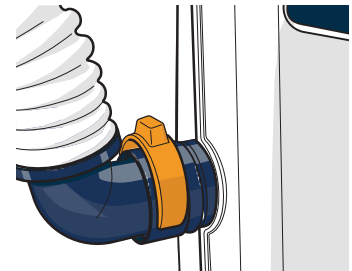

3. Push down the quick release button.

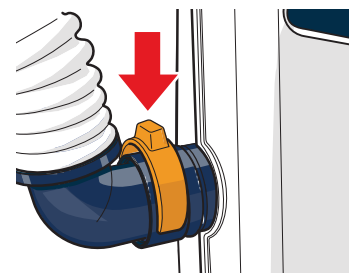

4. Pull out the hose from the blower.

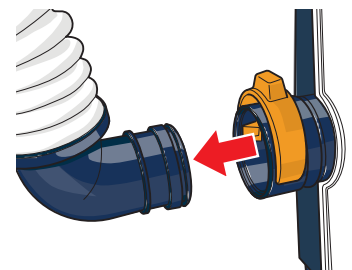

5. Attach a new hose by placing it in front of the quick connector.

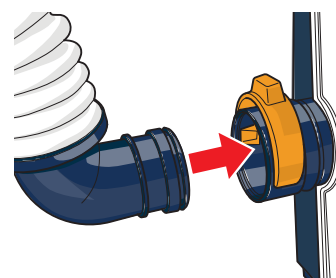

6. Press the connector firmly into the blower, until a "click" is produced.

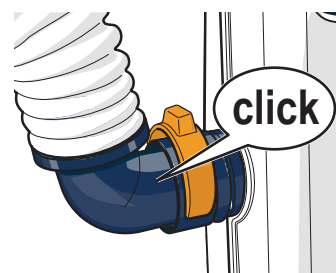

7. Check to ensure the connector is fully depressed.

8. Dispose of the QC Hose with other biohazardous medical waste, in closed bins and sent for medical burn waste according to local regulations.



Warning!

To attach the hose with a quick connector, firmly press the hose connector until the connector is fully depressed. Check to ensure the connector is securely locked on the blower.

8.3.4 Replacing the power cord



Warning!

- Use of accessories, transducers and cables other than those specified or provided by The Surgical Company International B.V. of this equipment could result in increased electromagnetic emissions or decreased electromagnetic immunity of this equipment and result in improper operation.
- Before performing corrective maintenance (see **Corrective maintenance** on page 42), disconnect the power supply cord to eliminate the risk of electrocution. There are electrically live parts within the system when it is connected to a power supply.
- The power cord may be a potential biohazard during and after use. Dispose of the power cord after decontamination (cleaning and/or disinfection), according to validated cleaning process. Handle and dispose of in accordance with accepted medical practice and applicable local regulations. In the EU following the Waste Electrical and Electronic Equipment (WEEE) Directive.



Caution!

Be careful not to scratch the front of the device.

1. Disconnect the device from the mains socket.
2. Place the device face-down on a soft surface.
3. Remove the mains cover using a 4 mm hex key.

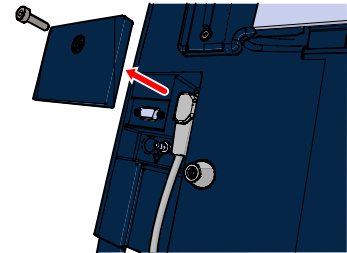
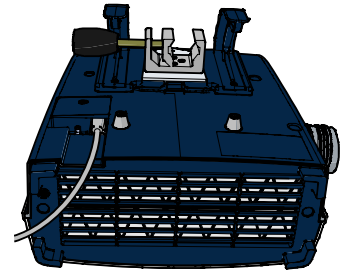

4. Unplug the C13 plug from the device.
5. Insert a new The Surgical Company International B.V. power supply cord and press it firmly into place.
6. Reattach the mains cover to lock the C13 plug by tightening the 4 mm hex screw with a maximum torque of 1.5 ± 0.2 Nm.
7. Perform an IEC 60601-1 electrical safety test.
8. Dispose of the power cord after decontamination (cleaning and/or disinfection), according to validated cleaning process. Handle and dispose of in accordance with accepted medical practice and applicable local regulations. In the EU following the Waste Electrical and Electronic Equipment (WEEE) Directive.

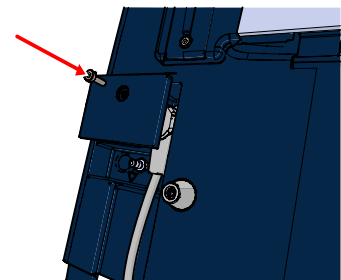

9 Troubleshooting

Problem	Possible Cause	Action
The device does not switch on.	Unplugged or damaged power cord	Make sure power cord is plugged in and is undamaged. Replace cord if necessary.
	No power to outlet	Confirm power to outlet.
	Poor or loose wire connections	Ensure all connectors and terminals are secure.
	Blown fuses at PCBA	Send the device to a certified service department for technical support.
The technical alarm is activated and the warming device stopped working.	Obstructed air flow path	If this alarm occurs, check for anything blocking the air flow path (e.g. blocked inlet, blocked hose end, or kink in the hose).
	Poor or loose wire connections, or damaged heater or electronics	
	Large mains power dip ($\geq 30\%$) for more than 1/60 of a second	Remove the obstruction(s), unplug the device from mains power, reconnect it and verify the alarm is gone. Press standby to activate the device again. In case of a recurring alarm, send the device to a certified service department for technical support.
The microcontroller watchdog alarm is activated.	Malfunctioning electronics	Send the device to a certified service department for technical support.
The device does not deliver enough air.	Obstructed air flow path	Check for anything blocking the air flow path and remove the obstacles.
	Clogged air filter	Send the device to the technical department to replace the filter with new filter supplied by The Surgical Company International B.V.
	Fan duty cycle set at low	Send the device to the technical department to set the fan duty cycle to normal.
Other technical problems.	Unidentified cause	Send the device to a certified service department for technical support.

10 Specifications

10.1 Specifications of the device

General specifications

Article number	MA1200-EU	MA1200-US
Rated voltage	220-240 V~	100-125 V~
Frequency	50/60 Hz	50/60 Hz
Device sound pressure	48 dBA	51 dBA
Average current	3.2 A	6.1 A
Peak current	9.0 A	10.0 A
Peak power	1000 VA	1000 VA
Average power at 43°C and t_{amb} 22 +/- 1.5°C	750 VA / 600 W	
Average power at 100.4°F and t_{amb} 71.6°F +/- 2.7°F		800 VA / 610 W
Fuses	6.3AHF/250V~	10AHF/250V~
Air flow rate at nominal voltages and ambient temperature (1.8 m / 71 in. hose)	Up to 101 m ³ /h or 59 CFM (depending on orientation of the hose, supply voltage, type and drape of the blanket)	Up to 88 m ³ /h or 52 CFM, (depending on orientation of the hose, supply voltage, type and drape of the blanket)
Air flow rate at nominal voltages and ambient temperature (1.8 m / 71 in. hose), low fan duty cycle	Up to 91 m ³ /h or 53 CFM (depending on orientation of the hose, supply voltage, type and drape of the blanket)	Up to 79 m ³ /h or 47 CFM, (depending on orientation of the hose, supply voltage, type and drape of the blanket)
EMDN (EU only)	36954 (circulating-air whole-body heating system control unit)	
GMDN code (US only)	36954 (circulating-air whole-body heating system control unit)	
Dimensions (l x w x h)	16 cm x 35 cm x 40 cm	6.3 in x 13.78 in x 15.75 in
Weight	5.2 kg	11.46 pounds
Hose length	1.8 m (3 m hose optional)	71 in. (118 in. hose optional)
Power supply cord length	4.0m	157.5 in.
Filtration	HEPA H13 class filter, conform EN 1822-1:2019	

Classification	MDR 2017/745/ EU Class IIb	FDA classification Class II
Classification IEC 60601-1	Class I, Body Floating (BF)	
Overvoltage category according to IEC 60664-1	Category II	
Classification IEC 60529	IP23	
Setpoint temperatures	Ambient air, 32°C, 38°C and 43°C	Ambient air, 89.6°F, 100.4°F and 109.4°F
Accuracy of temperature at the end of the hose	± 2.5 °C(under all validated operating environmental conditions)	± 4.5°F(under all validated operating environmental conditions)
Setpoint reached after	Under 30 seconds	
Low temperature limit	10°C	50°F
Maximum average contact surface temperature	45.5°C (Compliant with IEC 80601-2-35)	113.9°F(Compliant with IEC 80601-2-35)
High temperature safety limit	< 56°C (Compliant with IEC 80601-2-35)	< 132.8°F (Compliant with IEC 80601-2-35)
Auditory alarm signal sound pressure	72 dB(A) measured in a hemisphere with a radius of 1m / 39.4 in. from the geometric center of the device generating auditory alarm signal	
Applicable technical standards	IEC 60601-1:2005+A1:2012+A2:2020, EN IEC 60601-35:2021	
Expected lifetime device	7 years	
Expected lifetime hose	1 year	

The essential performance of the Mistral-Air Warming System is: when supplying air to the patient “the Maximum CONTACT SURFACE TEMPERATURE” must be below the safe temperature limits according to EN IEC 60601-2-35.

Validated operating environmental specifications

Ambient temperature	15°C to 30°C	59°F to 86°F
Relative humidity	30% to 75%	

Validated transport and storage specifications

Ambient temperature	-20°C to 70°C	-4°F to 158°F
Relative humidity	10% to 90% (non-condensing)	
Atmospheric pressure	50 kPa to 106 kPa	7.25 psi. to 15.37 psi

11 Electromagnetic compatibility



Warning!

- Use of accessories, transducers and cables other than those specified or provided by The Surgical Company International B.V. of this device could result in increased electromagnetic emissions or decreased electromagnetic immunity of this device and result in improper operation.
- Use of this device adjacent to or stacked with other equipment should be avoided because it could result in improper operation. If such use is necessary, this device and the other equipment should be observed to verify that they are operating normally.
- Portable RF communications equipment (including peripherals such as antenna cables and external antennas) should be used no closer than 30 cm (12 inches) to any part of the device, including cables specified by the manufacturer. Otherwise, degradation of the performance of this device could result.



- The Emissions characteristics of this device make it suitable for use in industrial areas and hospitals (CISPR 11 class A). If it is used in a residential environment (for which CISPR 11 class B is normally required) this device might not offer adequate protection to radio-frequency communication services. The user might need to take mitigation measures, such as relocating or reorienting the device.
- It is possible that a technical alarm is triggered at a 30% dip. Degradation does not affect ESSENTIAL PERFORMANCE and BASIC SAFETY and is therefore compliant. Refer to **Troubleshooting** on page 50 and **Specifications of the device** on page 51 for a solution.
- This device complies with IEC 60601-1-2:2014 for electromagnetic compatibility. However, if electromagnetic interference with nearby devices is experienced, the user is encouraged to take one or more of the following measures:
 - Isolate the offending device.
 - Reorient or relocate this device.
 - Increase the distance between the interfering device and this device.
 - Use another mains socket.

If electromagnetic incompatibility is still experienced, please contact your distributor.

11.1 Electromagnetic immunity

Guidance and manufacturer's declaration - electromagnetic immunity

The device is intended for use in the electromagnetic environment specified below. The customer or the user of the device should assure that it is used in such an environment.

Immunity test	IEC60601 test level
Electromagnetic discharge (ESD)	± 8 kV contact

Immunity test	IEC60601 test level
EN-IEC 61000-4-2 (2009)	± 15 kV air
Electrical fast transient (EFT) / burst EN-IEC 61000-4-4 (2012)	± 2 kV
Surge EN-IEC61000-4-5 (2014)	± 1 kV L-N ± 2 kV L-PE / N-PE
Voltage dips, short interruptions and voltage variations on power supply input lines EN-IEC 61000-4-11 (2004)	0% U _T for 0.5 cycle 0% U _T for 1 cycle 70% U _T for 25/30 cycles 0% U _T for 250/300 sec
Power frequency (50/60 Hz) magnetic field IEC EN-IEC 61000-4-8 (2010)	30 A/m
Conducted RF EN-IEC 61000-4-6 (2014)	3 V _{rms} + 6 V _{rms} (ISM + Amateur)
Radiated RF EN-IEC 61000-4-3 (2006) + A1 (2008) + A2 (2010)	3 V/m
Proximity fields from RF wireless communications equipment EN-IEC 61000-4-3 (2006) + A1 (2008) + A2 (2010)	9-28 V/m
Electrical transient conduction along supply lines ISO 7637-2 (2004)	Not applicable (system not intended for use in vehicles)

11.2 Electromagnetic emissions

Guidance and manufacturer's declaration – electromagnetic emissions

The device is intended for use in the electromagnetic environment specified below. The customer or the user of the device should assure that it is used in such an environment.

Emissions test	Compliance
RF emissions CISPR 11 (2015)	Group 1
RF emissions CISPR 11 (2015)	Class A
Harmonic emissions IEC 61000-3-2 (2018)	Not applicable (the device is suitable for use in all establishments other than domestic and those directly connected to the public low-voltage power supply network that supplies buildings used for domestic purposes)
Voltage fluctuations/flicker emissions IEC 61000-3-3 (2017)	

11.3 Recommended separation distances

Recommended separation distances between portable and mobile RF communications equipment and the device

The device is intended for use in an electromagnetic environment in which radiated RF disturbances are controlled. The customer or the user of the device can help prevent electromagnetic interference by maintaining a minimum distance between portable and mobile RF communications equipment (transmitters) and the device as recommended below, according to the maximum output power of the communications equipment.

Rated maximum output power of transmitter	Separation distance (d) according to frequency of transmitter		
	150 kHz to 80 MHz	80 MHz to 800 MHz	800 MHz to 2.5 GHz
0.01 W	0.12 m	0.12 m	0.24 m
0.1 W	0.37 m	0.37 m	0.74 m
1 W	1.17 m	1.17 m	2.34 m
10 W	3.69 m	3.69 m	7.38 m
100 W	11.67 m	11.67 m	23.34 m



- At 80 MHz and 800 MHz, the separation distance for the higher frequency range applies. [N033]
- These guidelines may not apply in all situations. Electromagnetic propagation is affected by absorption and reflection from structures, objects and people. [N034]

12 Disposal/End of life



Warning! The device and its single-use items may be a potential biohazard during and after use. Handle and dispose of in accordance with accepted medical practice and applicable local regulations.

12.1 Active devices

The active devices may be a potential biohazard during and after use. Dispose of the active devices after decontamination (cleaning and/or disinfection), according to validated cleaning protocol. Handle and dispose of in accordance with accepted medical practice and applicable local regulations. In the EU follow, the Waste Electrical and Electronic Equipment (WEEE) Directive.

12.2 Blankets and Suits or Single-use items

The blankets, suits and other single use items may be a potential biohazard during and after use. Dispose these items with other biohazardous medical waste, in closed bins and send for medical burn waste according to local regulations.

The Surgical Company International B.V.
Beeldschermweg 6F
3821 AH Amersfoort
+31 (0)33 450 72 50
The Netherlands
www.tsc-life.com
letsconnect@tsc-life.com



AS TO ELECTRICAL SHOCK, FIRE AND MECHANICAL HAZARDS ONLY
ANSI/AAMI ES60601-1:2005 + A1:2012 + A2:2021, IEC 60601-1-6:2010 + A1:2013 + A2:2020, ANSI/AAMI/IEC 60601-1-8:2006 + A1:2012 + A2:2021, IEC 60601-2-35:2020, CAN/CSA-C22.2 No. 60601-1-14 + A2:2022, CAN/CSA-C22.2 No. 60601-1-6:11 + A1:2015 + A2:2022, CAN/CSA-C22.2 No. 60601-1-8:08 + A1:2014 + A2:2022, CAN/CSA-C22.2 No. 60601-2-35:22

*This UL mark only applies to the MA1200-(QC-)US
